



Your partner for explosion protection

ATEX-approved products and know-how

BERNSTEIN has a professional practice in safety technology for 60 years

BERNSTEIN AG is one of the world's leading product and service providers in the field of safety technology for the electrical, chemical and mechanical engineering industry.

The emphasis of our more than 60 years of activity in the field of safety technology lies on advising and supplying our partners both with standard components and solutions. The **explosion protection (ATEX)** and the **machine safety (MRL)** form the technical framework.

Our system solutions can be used in safety-relevant and explosion-protected areas of zones 1, 2, 21 and 22. They are the connecting link between **Safety Integrity Level (SIL)** and **explosion protection (ATEX)**.

Our priority is customer satisfaction. The assurance of high quality and the solution to individual customer requirements are the central aspects of our daily work. The cost leadership due to optimised production processes also offers you the decisive economic advantage in addition to the many technical advantages.

The approvals and type examination certificates comply with the current state of the standards, the ATEX EC Directive and the Machinery Directive.

Our worldwide sales network ensures optimum local availability of our products and services.

BERNSTEIN offers

- The right product for your application
- Professional technical advice
- Engineering and project management from one provider
- Continuously monitored quality system
- Customer specific developments and approvals
- The right contact for all matters concerning explosion protection and machinery safety
- Product and professional trainings for ATEX applications
- Specialists who always have the latest know-how from internal and external basic and further training courses

All in one

- Approvals for customised products
- Application and product advice
- Product development
- Approval assistance according to GOST R and NEC
- Special delivery service for defined standard products
- Certified quality assurance system
- Approval assistance according to ATEX directive
- UL and CSA approvals
- Approval according to IEC Ex

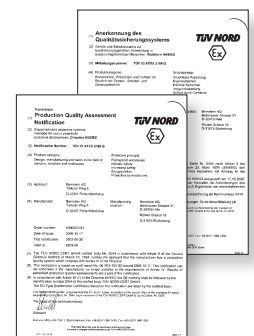

Products, industrial branches and end user



Industrial branches

- Chemical industry
- Petrochemical industry
- Medical and pharmaceutical technology
- Pharmaceutical industry
- Food industry
- Disposal and recycling industry
- Wood-working

End user

- Ex-protected plant operators
- Ex-protected plant manufacturers
- Planners and constructing engineer
- Ex-protected systems manufacturers



ATEX



Terminal boxes and empty enclosures

Only materials that correspond to the temperature range T6 required for Ex enclosures are used in these enclosures and components. The minimum type of protection rating of all enclosures and screw connections is IP 64, other protection classes available on request. The latching devices on the enclosures are available as captive screw connections. Various CA versions are available with flange plates. All built-in components must conform to the relevant approvals.



Momentary contact, cable pull and foot switches

An Ex d-certified switching element lies at the core of these Ex-approved switches. It is mounted in the switch enclosures. The mechanical actuator and its installation are certified separately. The approval of additional actuators and switch enclosures from other series is possible on request. All switches and momentary contact switches feature one NO contact and one NC contact.



Magnetic switches, Namur sensors

The protection against flammable energies is realised by encapsulation. The magnetic switches and Namur sensors are fitted at the factory with up to 7 m long connection cable. The cable is permanently connected to the enclosure and is part of the approval.

All sensors are certified for a maximum ambient temperature of +60 °C.









ATEX-approved products for potentially explosive atmospheres

- **Ex e, Ex ia** and **Ex e/ia** terminal boxes made from polyester and aluminium
- **Ex d** limit switches, rope pull switches and foot switches
- **Ex mb/Ex tD** magnetic switches

BERNSTEIN-ATEX experts' services:

- Approval of stainless steel enclosures (all dimensions)
- Approvals assistance for plant operators
- Approval of switching and control elements in all enclosures
- Approval of plug-in devices in all enclosures
- Customised component mounting and wiring of enclosures
- Training courses for planners and plant operators
- Cross-product system solutions
- Customer-specific development and project management on request
- **GOST** (Russia) and **NEC** (North America) approvals on request
- Approval according to **IEC Ex**

Explosion protection at a glance

Type approval to RAL 94/9/EC	Application	Explosion protection	Protection class	Device group	Temperature class	Inspection authority	Year	As per Directive 94/9/EC	Consecutive number	Additional conditions
	II2G	Ex	ia	IIC	T6	TÜV	2008	ATEX	1234	-
Types of protection for gas-explosion hazardous areas										
Symbol	Type of protection									Standard
	Ex "d"	Flameproof encapsulation Switching devices, motors, transformers etc. IEC60079-1								IEC60079-1
	Ex "p"	Pressurised encapsulation Control cabinets px = Use in Zone 1, 2 py = Use in Zone 1, 2 pz = Use in Zone 2								IEC60079-2
	Ex "q"	Powder-filled encapsulation Transformers, capacitors								IEC60079-5
	Ex "o"	Oil immersion encapsulation Transformers, load resistors								IEC60079-6
	Ex "e"	Increased safety Terminal boxes, control cabinets, enclosures for installing devices of other protection class								IEC60079-7
	Ex "i"	Intrinsically safe Terminal boxes, control cabinets, sensors, measurement and control equipment ia = Use in Zone 0, 1, 2 ib = Use in Zone 1, 2								IEC60079-11
		Intrinsically safe systems								IEC60079-25
	Ex "n"	Non sparking Systems that, due to their design, cannot spark								IEC60079-15
	Ex "m"	Encapsulation Command and signalling devices, sensors, display/indicator devices ma = Use in Zone 0,1,2 mb = Use in Zone 1,2								IEC60079-18
	Ex "op"	Optical radiation op is = Intrinsically safe optical radiation op pr = Protected optical radiation op sh = Shutdown optical radiation								IEC60079-28
IP Protection Classes										
IP 1st digit	Contact	Foreign bodies	IP 2nd digit	Water	Max. permissible surface temperature	Temperature classes for gases				
0	No protection	No protection	0	No protection						
1	Large body parts	Solid object > 50 mm	1	Water dripping vertically						
2	Finger	Solid object > 12.5 mm	2	Water dripping at angle up to 15°	450°	T1				
3	Tool > 2.5 mm	Solid object > 2.5 mm	3	Water sprayed at an angle up to 60°	300°	T2				
4	Tool > 1 mm	Solid object > 1 mm	4	Spayed water 360°	200°	T3				
5	Complete protection	Dust accumulation	5	Hose water 360°	135°	T4				
6	Complete protection	Dust infiltration	6	Strong hose water 360°	100°	T5				
			7	Temporary submersion	85°	T6				
			8	Submersion	Explosion groups for gases					
Device group I Mining					Group	Typical gas	Ignition energy			
IM1	Safety provided by 2 safety measures, 2 faults				I	Methane	280 µJ			
IM2	Shutdown on occurrence of explosive atmosphere				IIA	Propane	> 180 µJ			
Equipment group II, all hazardous areas except mining					IIB	Ethylene	60...180 µJ			
II 1	Zone 0	Zone 20	Safety provided by 2 safety measures, 2 faults		IIC	Hydrogen	< 60 µJ			
II 2	Zone 1	Zone 21	Safety in the event of frequent equipment malfunctions, 1 fault							
II 3	Zone 2	Zone 22	Safety in trouble-free operation							
Zone categories, device group II					Additional conditions					
Hazard					-	No restriction				
permanent or frequent		Gas as per IEC zone 0		Dust as per IEC zone 20	X	Special conditions				
occasional		zone 1		zone 21						
rare, temporary no longer than 30 min per year		zone 2		zone 22	U	Component certification, parts certification				

Examples of use

WDS – The confectionery machines of Winkler und Dünnebier GmbH



The confectionery machines made by **Winkler und Dünnebier** stand for quality, performance and reliability worldwide. **WDS** specialises in the production of moulding machines for the whole range of the confectionery industry. **WDS** encounters new challenges in this branch daily, making the search for a strong partner essential.

BERNSTEIN stands for high quality and individual consulting. Efficient, customer-oriented solutions are the goal. The implemented products are designed by our team of experts in our own Technology Centre according to customers' requirements.

The Mogul plant from **WDS** serves for the production of all powdered sweets made of jelly, gum, liquorice, fondant, cream, mousse, etc.

The explosion protection (ATEX) and the machine safety (MRL) form the technical basis for this. **BERNSTEIN** system solutions can be used in safety-relevant and explosion-protected areas of **zones 1, 2, 21 and 22**. They satisfy the specifications of the Safety Integrity Level (SIL) on the one hand and the explosion protection (ATEX) on the other. **BERNSTEIN** has successfully found the perfect combination of the Safety Integrity Level (SIL) and explosion protection (ATEX).

The **BERNSTEIN** housings are used to encapsulate electronics in the dust explosion area. **WDS** also uses the **BERNSTEIN** SHS3 switching hinge. This is a SIL3 safety switch. It protects safety doors at various stations in the plant.

SARTORIUS AG



SARTORIUS is an internationally leading provider of laboratory and process technology for the biotechnology, pharmaceuticals and food industries.

The most important customers are in the pharmaceuticals and chemical industries, however, customers from the food branch and numerous public research and educational institutions are not unimportant.

Use of **BERNSTEIN** products

Laboratory scales from **SARTORIUS** are fast and accurate. The ultra-microscales, microscales, analysis scales and precision scales are ideal for professional weighing. An application which is just the ticket for **BERNSTEIN**. **BERNSTEIN** was able to present the desired product in a very short time.

A great advantage is that **BERNSTEIN** provides both the project engineering and the project management.

The housing designed by **BERNSTEIN** is made of electrically polished high grade steel with metric screw connections and complies with protection class IP 66. The high quality electronics from **SARTORIUS** get reliable protection from the **BERNSTEIN** housing in the laboratory environment.

Aluminium and Polyester Blank enclosures CA, CP, CPS



ATEX-U certified standard enclosures

BERNSTEIN CA enclosures have been tested by an internationally recognised and certified inspection authority and certified through type approval testing for use in areas with potentially explosive dust and gas atmospheres. Used as terminal and control enclosures, the aluminium pressure die-cast and glass-fibre reinforced polyester enclosures are designed to accept corresponding mechanical and electrical equipment. The enclosures come with operating instructions, type identification plate, EU Type Approval Certificate and CE Declaration of Conformity. Either an EPDM or silicone seal can be used. The enclosures can be fitted at the factory with external hinges.

Technical Data

- **Protection class** IP 66 to IEC 60529 (special seal)
- **Identification**
 - ⊕ II 2G Ex e IIC Gb
 - ⊕ II 2D Ex tD A21 IP 65 (CA)
 - ⊕ II 1D Ex ta IIIC Da IP 66
- **Impact strength**
 - > 7 joules (CA)
 - up to CP-230 4 joules
 - as from CP-240 > 7 joules
- **Operating temperature** –55 °C to +100 °C (special seal)
- **CA**
 - Enclosure colour: RAL 7001 (silver grey)
 - Powder-coating corrosion protection
- **CP/CPS**
 - Enclosure colour: RAL 7000 (squirrel grey) CP
 - RAL 9005 (jet black) CPS
- **UV resistance**

Ordering data Blank enclosures

CA, CP, CPS

Type	External dimension (mm)	Art.No. with silicone seal	Art.No. with EPDM seal
CA-060	58 x 64 x 36	1064005000	1064000000
CA-080	98 x 64 x 36	1084005000	1084000000
CA-100	150 x 64 x 36	1104005000	1104000000
CA-130	75 x 80 x 57	1134005000	1134000000
CA-150	125 x 80 x 57	1154005000	1154000000
CA-170	175 x 89 x 57	1174005000	1174000000
CA-190	250 x 80 x 57	1194005000	1194000000
CA-210	122 x 122 x 80	1214005000	1214000000
CA-215	122 x 122 x 90	1214005050	1214000050
CA-220	122 x 122 x 80	1224005000	1224000000
CA-230	220 x 122 x 80	1234005000	1234000000
CA-235	220 x 122 x 90	1234005050	1234000050
CA-240	220 x 122 x 80	1244005000	1244000000
CA-250	360 x 122 x 80	1254005000	1254000000
CA-270	160 x 160 x 90	1274005000	1274000000
CA-280	160 x 160 x 90	1284005000	1284000000
CA-290	260 x 160 x 90	1294005000	1294000000
CA-300	260 x 160 x 90	1304005000	1304000000
CA-310	360 x 160 x 90	1314005000	1314000000
CA-330	560 x 160 x 90	1334005000	1334000000
CA-350	200 x 230 x 110	1354005000	1354000000
CA-360	200 x 230 x 180	1364005000	1364000000
CA-370	280 x 230 x 110	1374005000	1374000000
CA-380	330 x 230 x 110	1384005000	1384000000
CA-390	330 x 230 x 180	1394005000	1394000000
CA-400	400 x 230 x 110	1404005000	1404000000
CA-420	600 x 230 x 110	1424005000	1424000000
CA-450	402,5 x 310 x 110	1454005000	1454000000
CA-460	402,5 x 310 x 180	1464005000	1464000000
CA-470	600 x 310 x 110	1474005000	1474000000
CA-480	600 x 310 x 180	1484005000	1484000000
CP-140	80 x 75 x 55	4144005000	4144000000
CP-145	80 x 75 x 75	4144005050	4144000050
CP-150	110 x 75 x 55	4154005000	4154000000
CP-155	110 x 75 x 75	4154005050	4154000050
CP-170	160 x 75 x 55	4174005000	4174000000
CP-175	160 x 75 x 75	4174005050	4174000050
CP-190	190 x 75 x 55	4194005000	4194000000
CP-195	190 x 75 x 75	4194005050	4194000050
CP-220	122 x 120 x 90	4224005000	4224000000
CP-240	220 x 120 x 90	4244005000	4244000000
CP-280	160 x 160 x 90	4284005000	4284000000
CP-300	260 x 160 x 90	4304005000	4304000000
CP-320	360 x 160 x 90	4324005000	4324000000
CP-330	560 x 160 x 90	4334005000	4334000000
CP-370	255 x 250 x 120	4374005000	4374000000
CP-400	400 x 250 x 120	4404005000	4404000000
CP-450	400 x 405 x 120	4454005000	4454000000
CP-460	400 x 405 x 165	4464005000	4464000000
CPS-140	80 x 75 x 55	5144005000	5144000000
CPS-145	80 x 75 x 75	5144005050	5144000050
CPS-150	110 x 75 x 55	5154005000	5154000000
CPS-155	110 x 75 x 75	5154005050	5154000050
CPS-170	160 x 75 x 55	5174005050	5174000050
CPS-175	160 x 75 x 75	5174005050	5174000050
CPS-190	190 x 75 x 55	5194005000	5194000000
CPS-195	190 x 75 x 75	5194005050	5194000050
CPS-220	122 x 120 x 90	5224005000	5224000000
CPS-240	220 x 120 x 90	5244005000	5244000000
CPS-280	160 x 160 x 90	5284005000	5284000000
CPS-300	260 x 160 x 90	5304005000	5304000000
CPS-320	360 x 160 x 90	5324005000	5324000000
CPS-330	560 x 160 x 90	5334005000	5334000000
CPS-370	255 x 250 x 120	5374005000	5374000000
CPS-400	400 x 250 x 120	5404005000	5404000000
CPS-450	400 x 405 x 120	5454005000	5454000000
CPS-460	400 x 405 x 165	5464005000	5464000000

Aluminium and polyester terminal enclosures

The ATEX standard housings of the CA and CP series are designed as fully machined and assembled connection and wiring housings for use in **zones 1, 2 and 22**. They are machined and assembled according to the customer's needs and wishes. A combination of terminals and cable glands of various manufacturers is possible.

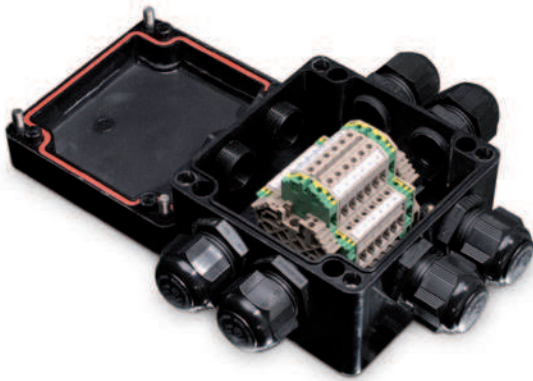

All common connecting terminals and cable glands can be combined.

- Screw terminals
- Direct push in terminals
- Wire piercing clamps
- Quick connect push terminals
- Single screw-type metal or plastic glands
- Multiple screw-type metal or plastic glands
- Special screw type glands for ribbon cables

The housings are designed in **enhanced safety and intrinsic safety protection** types or a combination of both.

A protection type up to IP 66 in accordance with ISO 60529 is possible depending on the seal. The operating temperature ranges from -55 °C to $+80\text{ °C}$ depending on the version.

All sizes of the empty housings are available as **assembled** housings. Either an earthing rail or an earthing clamp is used as an earth connection.

Accessories

Cable gland, plastic M12-M63



Serie ECDEP
(Standard)

- -20 °C to +80 °C, PA6
- IP 66/68, Ex e and Ex i

Cable glands, metal M12-M63



Serie EURO-Top X
(Standard)

- -20 °C to +80 °C, MS
- IP 66/68, Ex e

Screw terminals



TS15 (Standard)
TS35 (Standard)

- MBK 2,5 / AKZ 2,5
- UT 2,5 / WDU 2,5

Mounting plates



galvanised steel
laminated paper

- as from CP-370/CA
- up to CP-320

External mounting brackets



for mounting without
opening the covers

- stainless steel

Mounting rails



TS-35
TS-15

- as from CA-210/CP-220
- up to CA-190/CP-195

Earthing bars



as option
to PE terminals

- solid CU earthing
- as from CA-210/CP-220

Monitor housings for zone 2/22

To enable the use of controllers and operating units in explosive areas of **zones 2 and 22**, monitor and controller housings of the CC-4000 series, CC-800 series and the CA and CP series with customised assemblies can be used.

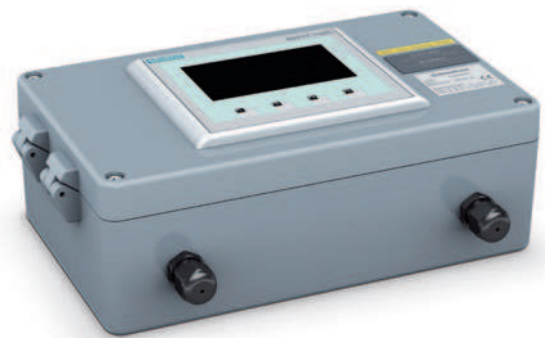

Zone 22

For operation in **zone 22** (Dust 3D) the housings are designed to ensure explosion protection type tc (pro-tection by housing). The basic preconditions for this are:

- Enclosure and suspension system **protection class IP 6x**
- All add-on parts with **type examination certificates or rather CE declaration of conformity for zone 22**
- **Max. permissible surface temperature +80 °C**
- The **assembly** of all externally accessible parts at BERNSTEIN AG
- Issuing of a **manufacturer declaration / CE declaration of conformity** for the complete housing by BERNSTEIN AG
- Documentation and monitored production by **ATEX-QA**

Zone 2

For operation in **zone 2** (Gas 3G) the housings are designed to ensure explosion protection type Ex nA (non-sparking device) and/or Ex i (intrinsic safety). The basic preconditions for this are:

- Enclosure and suspension system **protection class min. IP 54**
- All add-on and built-in parts with **type examination certificates or CE declaration of conformity for zone 2**



Accessories, built-in and add-on parts

Parts of all renowned manufacturers are used.
This include:

- Operator panel parts
- Terminals
- Touch panels
- Cable glands
- Power devices
- IPC Panels
- Signal lamps
- Alphanumeric displays

Stainless Steel Enclosure CC-800-Ex for zone 2/22



An enclosure created to protect

Thanks to its specific, individual concept, the redesigned CC-800 range of stainless steel control enclosures provides maximum security for your applications.

It is ideally suited for use in applications where the use of stainless steel is a legal requirement. Features such as high-quality workmanship, modern design and high-grade, durable material makes the CC-800 the first choice over enclosures made from other materials.

Our idea – your solution

With BERNSTEIN customer service you can be sure that our CC-800 will provide the perfect solution to your specific application.

We make your application requirements reality:

The combination of customer technology and BERNSTEIN stainless steel enclosures is the foundation for complete system integration. Special sizes, different surface finishes and suspension systems are only a few of the additional options that BERNSTEIN can realise for you.

Stainless steel technology to the highest standards

Product features

- Individual sizes within the housing concept, external dimens. min. 260 x 250 x 130 mm, max. 610 x 550 x 250 mm (configurable by Checklist)
- Modern design
- Foam seals
- Including earthing material and mounting plates
- Protection class IP 65
- Lock and hinges mounted laterally outside the protected area
- Reinforced seal frame for improved stability

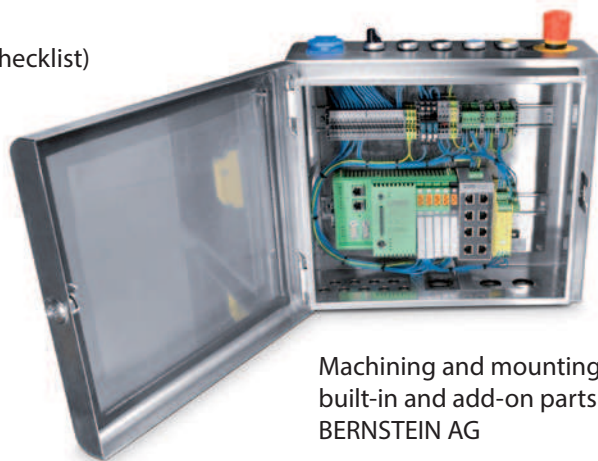

Machining and mounting built-in and add-on parts by BERNSTEIN AG

Material

- Enclosure, front door, lock stainless steel 1.4301, 1,5 mm steel plate

Surface finish

- Enclosure, front door, brushed finish, grain size 320

Available on request

- Different **surface finishes**
- **Wall mounting** (e.g. with brackets)
- **Special handles**
- **Additional components** such as suspension systems, handles and keyboard shelf
- **1.4401** also on demand

Stainless Steel Suspension System CS-480



Product features

The CS-480 NR suspension system was specifically developed for mounting control enclosures in hygienic areas in the food and pharmaceuticals industries.









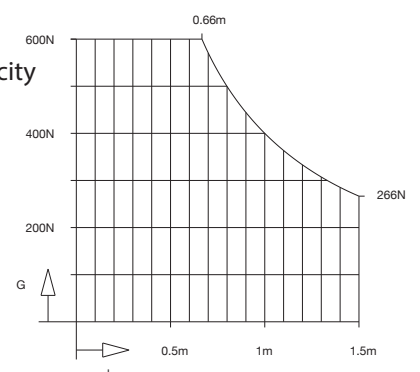







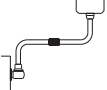

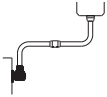







Thanks to the variety of different models, the CS-480 NR ensures absolute flexibility. You have the choice between a combination of tubes shaped to customer specifications and suspension system components or, if time is pressing, you can combine the pre-shaped tubes and coupling sleeves available from stock with the suspension system components.

You will find detailed information in the BERNSTEIN enclosure system catalogue. You have simply to call us.

System features

- Installation openings at bearing components with horizontal outlet
- Easy mounting by clamping the support tubes
- Torque preset at factory
- Material 1.4305
- Load bearing capacity 400 N at 1 m



Article	Size in mm	Article number	Weight	Image	Application example
1	CC-800 control enclosure	max. 610 x 550 x 250	customer-specific		Standard front door – attached on right, at top for suspension system
2	Coupling		1013050100	1,4 kg	 
	Pivot coupling		1013050300	1,0 kg	 
3	Tube, L-bend	250 x 250 500 x 500	9523500001 9523500011	1,8 kg 3,6 kg	
4	Coupling sleeve		1013051200	1,5 kg	 
5	Wall joint, vertical		1013050900	7,3 kg	 
	Wall coupling, vertical		1013051000	7,3 kg	 
	Wall bracket, vertical		1013051100	7,7 kg	 
6	Rotary base socket, internal mounting		1013050600	3,8 kg	 
7	Rotary base socket, external mounting		1013050500	4,2 kg	 
	Base socket / wall flange		1013050200	1,4 kg	 
	Base tilt coupling		1013050400	1,9 kg	 
	Rotary base coupling, external mounting		1013050700	4,5 kg	 
	Rotary base coupling, internal mounting		1013050800	4,1 kg	 
8	Support tubes, 48.3 mm outside diam., wall thickness 3.6 mm	250 500 750 1000 1250	9523501000 9523502000 9523503000 9523504000 9523505000	1,0 kg 1,9 kg 2,9 kg 4,0 kg 4,9 kg	
	Straight tubes	1500	9523506000	5,8 kg	

Suspension System CS-3000

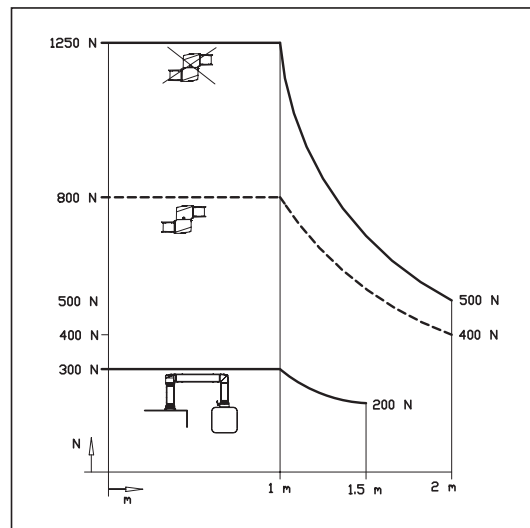

Load diagram

Product description

BERNSTEIN has available the adequate suspension system CS-3000 for the control enclosure CC-4000.

Modern industrial design, well-conceived safety features (six-fold form-fit in tube attachment area) and the unique possibility of a **one-man installation** of the whole system.

The components are supplied powder-coated in RAL 7016.













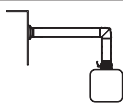

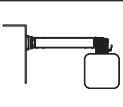



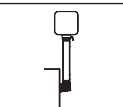

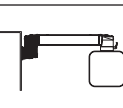

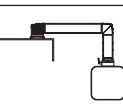
You will find detailed information in the BERNSTEIN enclosure system catalogue. You have simply to call us.

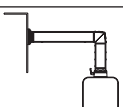
Aluminium tubing (70 x 90 mm)

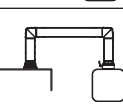
Silver anodised, machining on both tube ends

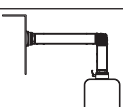
Standard lengths

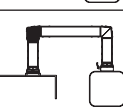
Standard lengths	Art.-No.
250 mm	9524500001
500 mm	9524500002
750 mm	9524500003
1000 mm	9524500004
1250 mm	9524500005
1500 mm	9524500006
1750 mm	9524500007
2000 mm	9524500008

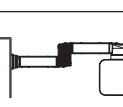
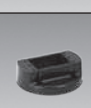
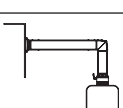
Article	Size in mm	Article number	Weight	Image	Application example
1	CC-4000 Control enclosure	max. 600 x 600 mm			
2	Coupling	1015300001	1,45 kg		
	Elbow coupling	1015300002	2,07 kg		
	Base coupling	1015300017	2,12 kg		
3	Wall joint vertical	1015300006	2,45 kg		
	Wall joint horizontal	1015300007	2,93 kg		
	Top joint	1015300003	2,25 kg		
4	Base socket / wall flange	1015300010	1,30 kg		
	Rotary base socket	1015300005	1,78 kg		
5	Elbow	1015300008	1,68 kg		
	Rotary elbow	1015300009	2,46 kg		
	Intermediate joint	1015300004	2,94 kg		
6	Adapter (for narrow sections)	1015300011	0,30 kg		

Sensors for potentially explosive atmospheres

BERNSTEIN offers a wide range of sensors for monitoring and controlling machines in areas with a risk of explosion. They include magnetic switches with reed contact, inductive NAMUR sensors and inductive sensors with switching output. The range of BERNSTEIN include many designs and sizes.



Technical Data Magnetic Switches

- Operating voltage range max. 250 V DC
- Output current max. 1 A
- Ambient temperature -20 °C to +60 °C
- Protection class IP 66
- Cable 3 x 0,75 mm²
- Red, PA enclosure
- Suitable for **zones 1, 2, 21, 22 (2G/2D)**

Technical Data Sensors

Type	Article number ATEX	Sensor type
MAK-1513-LEX-3	6316315001	Magnetic switch
MAK-1513-LEX-1	6316315308	Magnetic switch
MAK-1513-LEX-7	6316315344	Magnetic switch
MAK-1513-LEX-10	6316315654	Magnetic switch
KIB-M05EA/001-2G	6521699002	NAMUR sensor M5 flush
KIB-M08EA/1,5-2G	6521601003	NAMUR sensor M8 flush
KIB-M12EA/002-2G	6521624004	NAMUR sensor M12 flush
KIB-M18EA/005-2G	6521626005	NAMUR sensor M18 flush
KIB-M30EA/010-2G	6521699006	NAMUR sensor M30 flush
KIN-M08EA/002-2G	6521601007	NAMUR sensor M8 non-flush
KIN-M12EA/004-2G	6521625008	NAMUR sensor M12 non-flush
KIN-M18EA/008-2G	6521627001	NAMUR sensor M18 non-flush
KIB-M12PS/002-KL2D	6522903009	Inductive sensor M12 flush
KIN-M12PS/004-KL2D	6522904010	Inductive sensor M12 non-flush
KIB-M12PS/002-KLS12D	6522943011	Inductive Sensor M12 flush
KIN-M12PS/002-KLS12D	6522944012	Inductive sensor M12 non-flush
KIB-M18PS/005-KL2D	6522905013	Inductive sensor M118 flush
KIN-M18PS/008-KL2D	6522906014	Inductive sensor M18 non-flush
KIB-M18PS/005-KLS12D	6522905015	Inductive sensor M18 flush
KIN-M18PS/008-KLS12D	6522906016	Inductive sensor M18 non-flush
KIB-M30PS/010-KL2D	6522907017	Inductive sensor M30 flush
KIN-M30PS/015-KL2D	6522908018	Inductive sensor M30 non-flush
KIB-M30PS/010-KLS12D	6522907019	Inductive sensor M30 flush
KIN-M30PS/015-KLS12D	6522908020	Inductive sensor M30 non-flush

Technical Data NAMUR Sensors

- Operating voltage range max. 30 V DC
- NAMUR output
- Ambient temperature -25 °C to +60 °C
- Protection class IP 67
- Cable from 2 x 0,14 mm² up to 2 x 0,5 mm²
- Metal enclosure from M5 up to M30
- Suitable for **zones 2, 22 (3G/3D)**

Technical Data Inductive Sensors

- Operating voltage range 10–25 V DC
- Output current < 200 mA
- PNP switching output
- Ambient temperature -25 °C to +70 °C
- Protection class IP 67
- Cable connection
- Metal enclosure from M12 up to M30
- Suitable for **zones 2, 22 (3G/3D)**

Electromechanical Switches for potentially explosive atmospheres



An Ex d-certified snap-action switch lies at the core of the Ex-approved switches. This switch with protection class **flameproof encapsulation** can be used in **zones 1 and 2**.

The snap-action switch has two galvanically isolated contacts, one NC contact and one NO contact. It is designed for use as a mechanically protected built-in switch in housings, control and monitoring devices. It is available with different actuators for this purpose.

The switch insert is also used in various switch housings with different actuating devices.

For potentially explosive atmospheres, BERNSTEIN proposes the **ENM2** and **GC** series as position switches, the **F** series as foot switches and the **SD** series as rope pull switches.

However, the **SI2** and **SN3** series as rope pull switches and belt alignment switches are also possible for the use in **zones 21 and 22**.

Snap-action Switch EEX-SU1...

Type	Article number	Type of switch
EEX-SU1Z W-2M-	6090153002	Version with plunger 2 m cable
EEX-SU1Z W-9M-	6090153005	Version with plunger 9 m cable
EEX-SU1Z RH-2M-	6090148022	Version with roller lever 2 m cable
EEX-SU1Z RH-5M-	6090148024	Version with roller lever 5 m cable
EEX-SU1Z RH-9M-	6090148025	Version with roller lever 9 m cable
EEX-SU1Z RHL-2M-	6090149027	Version with roller lever lang 2 m cable
EEX-SU1Z RHL-5M-	6090149029	Version with roller lever lang 5 m cable
EEX-SU1Z UH-2M-	6090146012	Version with extended stroke lever 2 m cable
EEX-SU1Z UH-5M-	6090146014	Version with extended stroke lever 5 m cable
EEX-SU1Z FH-2M-	6090145007	Version with flat lever 2 m cable
EEX-SU1Z FH-9M-	6090145010	Version with flat lever 9 m cable

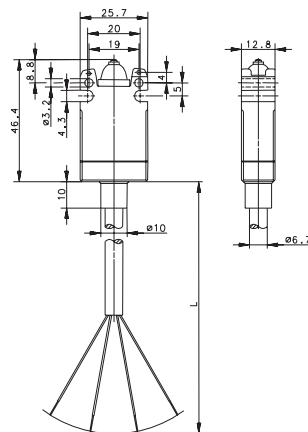

Technical Data EEX-SU1Z

- Certification Ex II 2G Ex d IIC T6
- Rated insulation voltage 250 V
- Rated operating voltage 230 V AC
- Conventional thermal current 5 A
- Utilization category / switching capacity
AC 15 240 V / 3 A
DC 13 250 V / 0,27 A
- Mechanical switching frequency max. 120 / min.
- Mechanical service life
2 x 10⁶ switching cycles
- 1 NC / 1 NO
- B10d: 4 million
- Suitable for **zones 1, 2 (2G)**
- Admissible ambient temperature -20 °C to +60 °C
- Protection class IP 66 according to IEC 60529
- PEI enclosure

Position Switch series ENM2 and GC, Rope Pull Switch SD

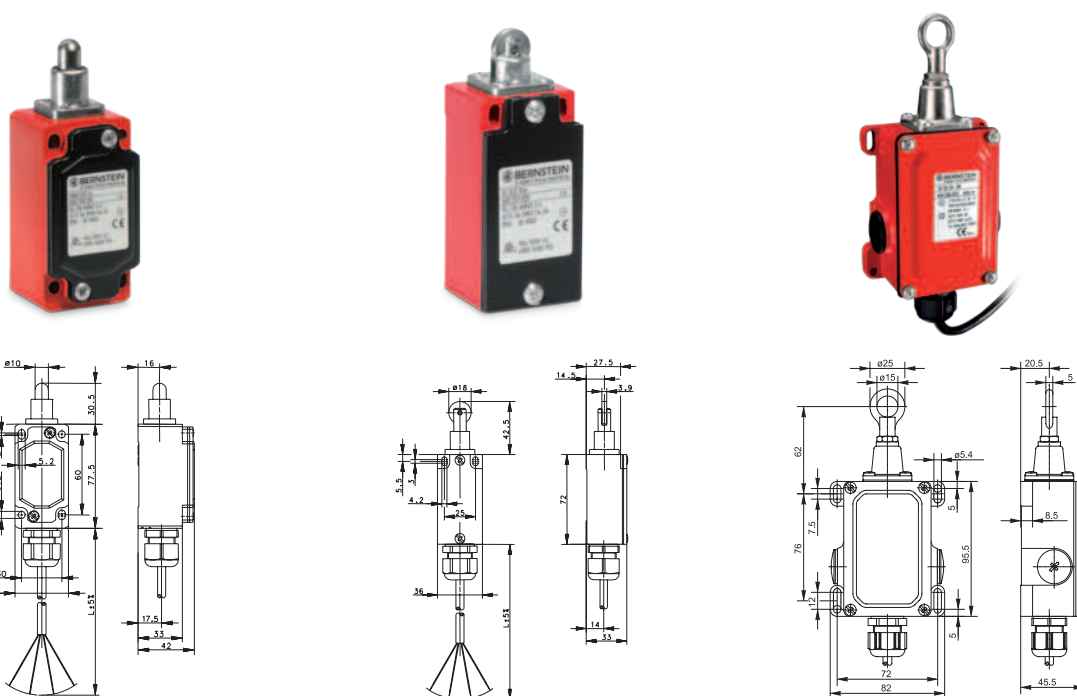

Types ENM2 and GC

- Standard switch conforming to DIN EN 50041
- Standard actuator conforming to DIN EN 50041, Type A, B, C, D
- Protection class IP 66 to VDE 0470 T1
- Aluminium pressure die-casting enclosure
- Sheet aluminium cover
- Actuator can be repositioned by 4 x 90°
- Cable entry M20 x 1.5
- Metal actuators for high loads

Ordering data

ENM2, GC and SD

Type	Article number	Type of switch
ENM2-SU1Z EX IW -2M-	6097152052	Version with plunger 2 m cable
ENM2-SU1Z EX IW -5M-	6097152054	Version with plunger 5 m Cable
ENM2-SU1Z EX IW -9M-	6097152055	Version with plunger 9 m Cable
ENM2-SU1Z EX HW -2M-	6097171072	Version with lever 2 m cable
ENM2-SU1Z EX HW -5M-	6097171074	Version with lever 5 m cable
ENM2-SU1Z EX HW -9M-	6097171075	Version with lever 9 m cable
ENM2-SU1Z EX RIW -2M-	6097167062	Version with roller 2 m cable
ENM2-SU1Z EX RIW -5M-	6097167064	Version with roller 5 m cable
ENM2-SU1Z EX RIW -9M-	6097167065	Version with roller 9 m Cable
ENM2-SU1Z EX AHT -2M-	6097185082	Version with spindle-mounted lever 2 m cable
ENM2-SU1Z EX AHT -5M-	6097185084	Version with spindle-mounted lever 5 m cable
ENM2-SU1Z EX AHT -9M-	6097185085	Version with spindle-mounted lever 9 m cable
ENM2-SU1Z EX AD -2M-	6097187092	Version with spindle-mounted lever Draht 2 m cable
ENM2-SU1Z EX AD -5M-	6097187094	Version with spindle-mounted lever Draht 5 m cable
ENM2-SU1Z EX AD -9M-	6097187095	Version with spindle-mounted lever Draht 9 m cable
ENM2-SU1Z EX FF -2M-	6097190097	Version with spring feeler 2 m cable
ENM2-SU1Z EX FF -5M-	6097190099	Version with spring feeler 5 m cable
ENM2-SU1Z EX FF -9M-	6097190100	Version with spring feeler 9 m cable
GC-SU1Z EX IW -2M-	6092152002	Version with plunger 2 m cable
GC-SU1Z EX IW -5M-	6092152004	Version with plunger 5 m cable
GC-SU1Z EX IW -9M-	6092152005	Version with plunger 9 m cable
GC-SU1Z EX HW -5M-	6092171024	Version with lever 5 m cable
GC-SU1Z EX HW -9M-	6092171025	Version with lever 9 m cable
GC-SU1Z EX RIW -2M-	6092167012	Version with roller 2 m cable
GC-SU1Z EX RIW -9M-	6092167015	Version with roller 5 m cable
GC-SU1Z EX AHW -2M-	6092185032	Version with spindle-mounted lever 2 m cable
GC-SU1Z EX AHW -5M-	6092185034	Version with spindle-mounted lever 5 m cable
GC-SU1Z EX AHW -9M-	6092185035	Version with spindle-mounted lever 9 m cable
SD-SU1 EX -2M-	6091100002	Version with 2 m cable
SD-SU1 EX -5M-	6091100004	Version with 5 m cable
SD-SU1 EX -9M-	6091100005	Version with 9 m cable

Technical Data ENM2, GC and SD

- Identification Ex II 2G Ex d IIC T6
- Rated insulation voltage 250 V
- Rated operating voltage 230 V AC
- Conventional thermal current 5 A
- Utilization category / switching capacity:
AC 15 240 V / 3 A
DC 13 250 V / 0,27 A
- Mechanical switching frequency max. 50 / min.
- Mechanical service life
2 x10⁶ switching cycles
- 1 NC / 1 NO
- B10d: 4 million
- Suitable for **zones 1, 2 (2G)**
- Admissible ambient temperature –20 °C to +60 °C
- Protection class IP 66 according to IEC 60529
- Aluminium pressure die-casting enclosure

Foot Switch series F, Rope Pull Switch and Belt Alignment Switch series SI2

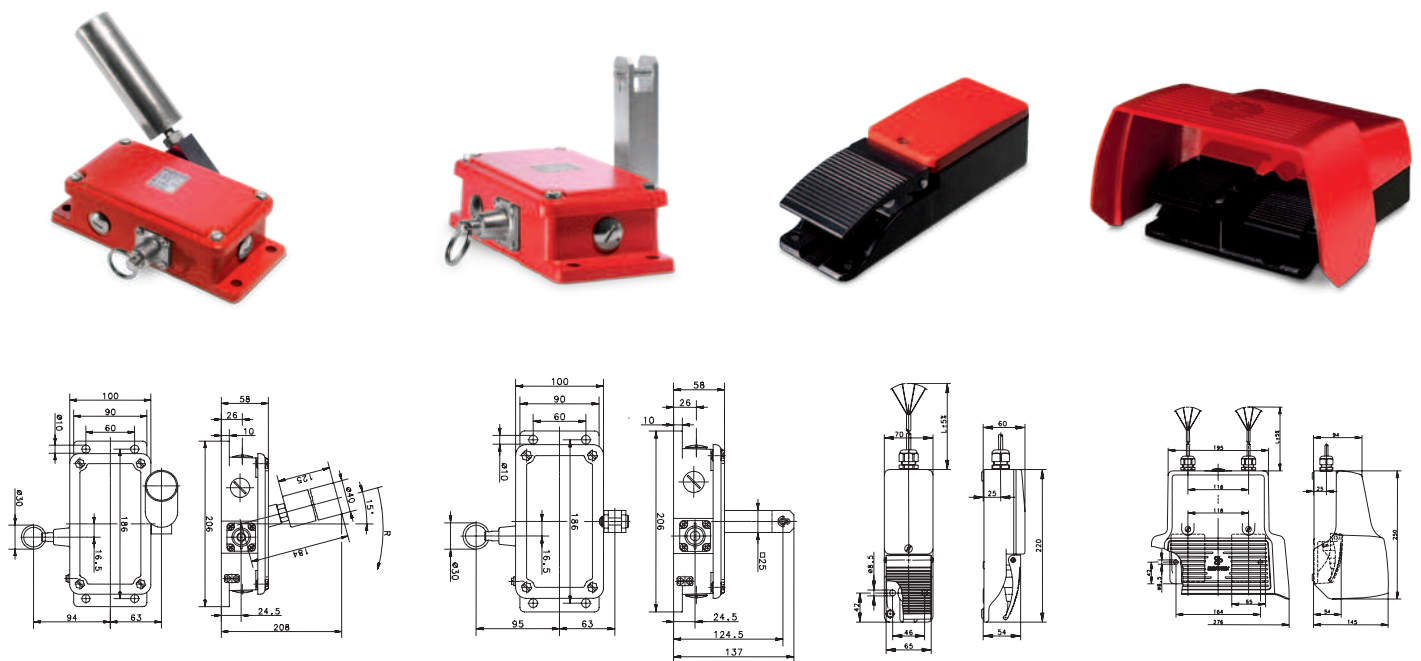

Belt alignment switch

In conveyor belt applications, the safety switch prevents conveyor belts from being damaged or being destroyed as the result of the belt running off track. When the roller lever is deflected by a conveyor belt running off track the safety contacts in the switch engage, thus shutting down the conveyor belt. Only after eliminating the cause of the malfunction can the system be restarted by means of the pull release (key ring).

Rope pull switch

BERNSTEIN double-spanned cable pull switches SI2 are also used in emergency stop applications. When the cable is pulled the switching lever is deflected in the corresponding direction and the system shut down. These rope pull switches can be used in applications with high temperature fluctuations and long cable spans. With their sturdy enclosure, these switches are perfect for harsh environments. Two cables spanned in opposite directions are attached to the switching device. The counter springs are secured to the wall at the ends of the cables. Provided the change in temperature is the same at all points along the cable, the springs will effectively compensate for the change in cable length.

Footswitch

BERNSTEIN offers you a wide range of foot switches to meet exacting requirements in industrial applications. They can be optionally equipped with an aluminium cover panel or a protective hood (UN) and have the protection class IP 66. The ambient temperature can reach from $-30\text{ }^{\circ}\text{C}$ up to $+60\text{ }^{\circ}\text{C}$. The mounting holes make it possible to anchor the foot switch to the floor. Each foot switch is equipped with four rubber feet to prevent it slipping. The separators on multi-pedal foot switches prevent several pedals being inadvertently operated simultaneously (version without separators available on request). Type F1–F3 foot pedals are made from a thermoplastic material.

Ordering data

Type	Article number	Type of switch
F1-SU1Z EX UN-2M-	6096197017	Foot switch 1 pedal with protective hood 2 m cable
F1-SU1Z EX UN-5M-	6096197019	Foot switch 1 pedal with protective hood 5 m cable
F1-SU1Z EX -5M-	6096198014	Foot switch 1 pedal without protective hood 5 m cable
F2-SU1Z EX UN-5M-	6096197029	Foot switch 2 pedals with protective hood 5 m cable
F1-SU1Z EX -2M-	6096198022	Foot switch 2 Pedale without protective hood 2 m cable
SI2-U2Z AW EXD	6091295025	Belt alignment switch
SI2-U2Z AK EXD	6091288024	Rope pull switch

Technical Data SI2 series

- Identification Ex II 3D Ex tD A22 IP65 T80°C
- Rated insulation voltage 400 V
- Rated operating voltage 240 V AC
- Conventional thermal current 10 A
- Utilization category /switching capacity:
AC 15 240 V / 3 A
- Mechanical switching frequency max. 10 / min.
- Mechanical service life
2 x 10⁶ switching cycles
- 2 NC / 2 NO
- B10d: 4 million
- Suitable for **zones 22 (3D)**
- Admissible ambient temperature –20 °C to +60 °C
- Protection class IP 65 according to IEC 60529
- Metal enclosure

Technical data foot switches

- Identification Ex II 2G Ex d IIC T6
- Rated insulation voltage: 250 V
- Rated operating voltage 230 V AC
- Conventional thermal current 5 A
- Utilization category /switching capacity:
AC 15 240 V / 3 A
DC 13 250 V / 0,27 A
- Mechanical switching frequency max. 50 / min.
- Mechanical service life
2 x 10⁶ switching cycles
- 1 NC / 1 NO
- B10d: 4 million
- Suitable for **zones 1, 2 (2G)**
- Admissible ambient temperature –20 °C to +60 °C
- Protection class IP 66 according to IEC 60529
- Aluminium pressure die-casting enclosure

Checklist – Control Enclosure CC-4000Ex

Customer	*Product group	*Code	*Article number
Address			Customer No.
Telephone	Telefax	Industry	
Contact person		Department	
<input type="checkbox"/> Pricing enquiry			
		Target price	Quantity
<input type="checkbox"/> Enquiry			
		*Enquiry No.	Annual requirement
<input type="checkbox"/> Order			
Delivery date			

1 Enclosure

- Standard
- Console enclosure, upper section
- Console enclosure, lower section.

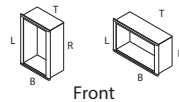

Anticipated installation weight _____ kg

2 Dimensions (mm)

Ext. enclosure dim.

Width x height (W x H) _____ x _____

*Front panel dim.

e x f = W - 111 x H - 97 _____ x _____

*Rear panel dim.

B x H = W - 61 x H - 47 _____ x _____

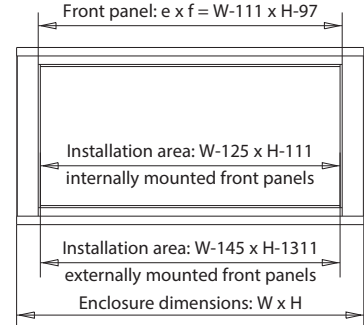

3 Enclosure depth, ext.

Frame section

with 3 mm deep FP support

_____ → 140 200 290

or _____ → 52 80
with 6.5 mm deep FP support

Expansion

**Internal depth with internally mounted 4 mm FP

68 128 228 128 68

68 128 228 128 68

The internal depth is reduced by 2.5 mm with 6.5 mm FP

Profil	52	80	120	140	148	180	188	200	208	216	248	268	276	280	290	308	328	336	348	358	368	376	396	408	418	426	428	436	456	486	496	518	A	
	37	65	105	125	133	165	173	185	193	201	233	253	261	265	275	293	313	321	333	343	353	361	381	393	403	411	413	421	441	471	481	503	I**	
52	•		•			•	•				•			•		•			•					•										
80		•			•				•	•			•			•		•			•		•						•					
140				•						•		•	•					•			•		•						•				•	
200								•				•					•	•			•		•		•				•				•	
290															•					•				•		•							•	
68			•		•		•		•	•	•	•	•					•	•	•		•	•				•		•			•	•	
68							•			•			•					•									•							
128						•			•		•	•	•				•	•	•					•	•	•			•		•	•	•	
128															•			•						•										
228														•		•				•		•	•		•			•	•	•	•	•	•	

A = External depth, I = Internal depth Internal depth is increased by 7 mm for external mounting. ◆ = Alternative combination

* Completed by BERNSTEIN AG

4 Door mounting (suspension system)

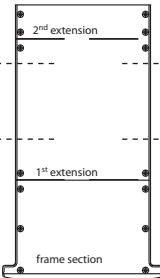
<input type="checkbox"/> 2 nd extension	<input type="checkbox"/>		<input type="checkbox"/>	<input type="checkbox"/> 2 nd extension
<input type="checkbox"/> 1 st extension Section/fixed rear panel	<input type="checkbox"/>	Door mounting L	<input type="checkbox"/>	<input type="checkbox"/> 1 st extension
		frame section	R Door mounting	<input type="checkbox"/> Frame section (from 140) Suspension system position

5 Front panel (4 mm)

-
- internally mounted
-
- externally mounted

Rear panel (3 mm)

externally screw-mounted

6 Lock

- | | | | |
|------------------------|--------------------------------|----------------------------|---------------------------------------|
| Square (mm) | <input type="checkbox"/> 6 | <input type="checkbox"/> 7 | <input type="checkbox"/> 8 (Standard) |
| Triangle (mm) | <input type="checkbox"/> 7 | <input type="checkbox"/> 8 | |
| Two-way bit (mm) | <input type="checkbox"/> 3 | <input type="checkbox"/> 5 | |
| T-handle with lock | <input type="checkbox"/> | | |
| Customer specification | <input type="checkbox"/> _____ | | |

7 Preparation for suspension system
 No

Type of coupling

-
- Turn/tilt coupling (from section 128)
-
-
- Flange (see system on the right)
-
-
- Tilt adapter (from section 200)
-
-
- Coupling head CC-4000
-
-
- Spec. preparation to customer specif.

-
- Console connector
-
-
- CS-3000/48
-
-
- SS in section ____

System

-
- SL (only section 80)
-
-
- CS-3000 (from section 128)
-
-
- 80 (from section 128)
-
-
- SS cover, top
-
-
- SS cover bottom

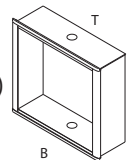
 Top

 Bottom

8 Surface finish
Standard

- | | |
|----------------------|---|
| Horizontal sections: | <input type="checkbox"/> RAL 7043, power-coated |
| Vertical sections: | <input type="checkbox"/> anodised, natural |
| Front panels: | <input type="checkbox"/> anodised, natural |
| Rear panels: | <input type="checkbox"/> anodised, natural |

Customer specification

9 Climate control data for checking heat dissipation over enclosure surface

____ (Pv) total installed power loss ____ (°C) ambient temperature ____ (°C) max. temperature of installation

10 Application in zone

-
- 2 (gas) Ex nA
-
- 2 (gas) Ex i
-
- 22 (dust) Ex tc

11 Accessories, Remarks:

12 General information:

Protection class in zone 2 min IP 54, in zone 22 min IP 64. All built-in and add-on parts for zone 2 must be suitable and certified. All add-on parts are mounted at the factory. Control and operator components of all leading providers are being used.

Checklist – Pre-assembled standard enclosures in EX version

Customer	
Contact person	
Telephone	
Annual requirement	Delivered lot size

The pre-assembled standard enclosures in EX version can be used in zones 1 and 2 and are delivered in the following explosion protection types:

- | | | |
|--|--|---|
| <input type="checkbox"/> Exi (Intrinsically safe)
⊕ II 2G EEx ia IIC T6 | <input type="checkbox"/> Exe (Increased safety))
⊕ II 2G EEx e IIC T6 | <input type="checkbox"/> Exi+e (Mixed assembly)
⊕ II 2G EExe ia IIC T6 |
|--|--|---|

Configuration

1. Enclosure material

<input type="checkbox"/> Aluminium CA series	<input type="checkbox"/> Stainless steel CC series (approval in process)	<input type="checkbox"/> Polyester CP series
Enclosure type: Dimensions: Colour: <input type="checkbox"/> RAL 7001 (standard) <input type="checkbox"/> RAL Type of cover locking: <input type="checkbox"/> Screws cross recessed head (standard) <input type="checkbox"/> Hexagon socket head cap (from CA-210) Articulated hinges: Side <input type="checkbox"/> A <input type="checkbox"/> B <input type="checkbox"/> C <input type="checkbox"/> D <input type="checkbox"/> External articulated hinges (from CA-210) <input type="checkbox"/> Internal articulated hinges (from CA-210) Cover seal: <input type="checkbox"/> EPDM (–35 °C to +80 °C) <input type="checkbox"/> Silicone (–55 °C to +100 °C)	Enclosure type: Dimensions: Colour: <input type="checkbox"/> Stainless steel Type of cover locking: <input type="checkbox"/> Screws cross recessed head <input type="checkbox"/> Sash lock Cover seal: <input type="checkbox"/> EPDM (–35 °C to +80 °C) <input type="checkbox"/> Silicone (–55 °C to +100 °C)	Enclosure type: Dimensions: Colour: <input type="checkbox"/> RAL 7000 (standard) <input type="checkbox"/> RAL 9005 (standard) Type of cover locking: <input type="checkbox"/> Screws cross recessed head (standard) <input type="checkbox"/> Hexagon socket head cap Articulated hinges: Side <input type="checkbox"/> A <input type="checkbox"/> B <input type="checkbox"/> C <input type="checkbox"/> D <input type="checkbox"/> External articulated hinges (from CP-220) <input type="checkbox"/> Internal articulated hinges (from CP-280) Cover seal: <input type="checkbox"/> EPDM (–35 °C to +80 °C) <input type="checkbox"/> Silicone (–55 °C to +100 °C)

2.1 Internal system

<input type="checkbox"/> Mounting rail	<input type="checkbox"/> Mounting plate
<input type="checkbox"/> TS 35 (from CA-210 / CP-220) <input type="checkbox"/> TS 15 (up to CA-190 / CP-195) <input type="checkbox"/> Distance sleeves 8,5 mm <input type="checkbox"/> Distance sleeves: mm	
<input type="checkbox"/> Earthing terminals	<input type="checkbox"/> Earthing rail (from enclosure dim. CA-210, CP-220)
Type Pieces	
Connecting terminal plate (system)	
Type of terminals:	
Number of terminals:	
Arrangement of terminals:	
Identification of connecting terminal plate (ex.: X1):	
Identification of terminals (ex.: 1, 2, 3 ...):	

Terminals	(Rated cross section 1,5 mm ² up to 35 mm ²)			
Manufacturer	<input type="checkbox"/> Phoenix-Contact	<input type="checkbox"/> Weidmüller	<input type="checkbox"/> Customer specification	
Mounting rail:	TS 35	TS 15	TS 35	TS 15
Type:	UT 2,5	MBK 2,5	WDU 2,5	AKZ 2,5
Conductor cross section:	2,5 mm ²	2,5 mm ²	2,5 mm ²	2,5 mm ²
Current:	22 A	22 A	21 A	21 A
Voltage:	690 V	176 V	550 V	176 V
Width:	5,2 mm	5,2 mm	5,1 mm	6 mm
Connection:	Screw		Screw	

2.2 External system

Machining / Mounting

Side A, mounted with:	M12	M16	M20	M25	M32	M40	M50	M63	Version	
									Plastic	Metal
Number of screw threads									<input type="checkbox"/>	<input type="checkbox"/>
Number of cable glands									<input type="checkbox"/>	<input type="checkbox"/>
Number of blanking plugs									<input type="checkbox"/>	<input type="checkbox"/>
Number of dummy plugs									<input type="checkbox"/>	<input type="checkbox"/>
Side B, mounted with:	M12	M16	M20	M25	M32	M40	M50	M63	Version	
Number of screw threads									<input type="checkbox"/>	<input type="checkbox"/>
Number of cable glands									<input type="checkbox"/>	<input type="checkbox"/>
Number of blanking plugs									<input type="checkbox"/>	<input type="checkbox"/>
Number of dummy plugs									<input type="checkbox"/>	<input type="checkbox"/>
Seite C, mounted with:	M12	M16	M20	M25	M32	M40	M50	M63	Version	
Number of screw threads									<input type="checkbox"/>	<input type="checkbox"/>
Number of cable glands									<input type="checkbox"/>	<input type="checkbox"/>
Number of blanking plugs									<input type="checkbox"/>	<input type="checkbox"/>
Number of dummy plugs									<input type="checkbox"/>	<input type="checkbox"/>
Seite D, mounted with:	M12	M16	M20	M25	M32	M40	M50	M63	Version	
Number of screw threads									<input type="checkbox"/>	<input type="checkbox"/>
Number of cable glands									<input type="checkbox"/>	<input type="checkbox"/>
Number of blanking plugs									<input type="checkbox"/>	<input type="checkbox"/>
Number of dummy plugs									<input type="checkbox"/>	<input type="checkbox"/>

BERNSTEIN Standard Cable glands: RST, Typ Euro Top (Polyamid)

Plastic cable gland – Euro Top X (polyamide)

Type	Dimension	Clamping range		* 
K	M12 x 1.5	3.00	6.50	15
K	M16 x 1.5	5.00	10.00	22
K	M20 x 1.5	7.00	13.00	24
K	M25 x 1.5	13.00	18.00	33
K	M32 x 1.5	18.00	25.00	42
K	M40 x 1.5	22.00	32.00	53
K	M50 x 1.5	30.00	38.00	60
K	M63 x 1.5	34.00	44.00	65

*  WAF in mm

External mounting brackets (from CP-140 / CA-210):	<input type="checkbox"/> yes	<input type="checkbox"/> no		
Documentation and danger sign (acc. to customer specif.):	<input type="checkbox"/> German	<input type="checkbox"/> English	<input type="checkbox"/> French	<input type="checkbox"/> others:
Accessories, remarks:				
Annexes:	<input type="checkbox"/> yes	<input type="checkbox"/> no		
Annexes' types: (for ex. , customer drawings, written agreement etc.)				



**Switch systems –
Economy meets safety**



**Sensor systems –
Compact intelligence**



**Enclosure systems –
Function and design**

www.bernstein.eu

Contact

**International Headquarters
BERNSTEIN AG**
Hans-Bernstein-Str. 1
32457 Porta Westfalica
Fon +49 571 793-0
Fax +49 571 793-555
info@de.bernstein.eu
www.bernstein.eu

**Denmark
BERNSTEIN A/S**
Fon +45 7020 0522
Fax +45 7020 0177
info@dk.bernstein.eu

**France
BERNSTEIN S.A.R.L.**
Fon +33 1 64 66 32 50
Fax +33 1 64 66 10 02
info@fr.bernstein.eu

**Italy
BERNSTEIN S.r.l.**
Fon +39 035 4549037
Fax +39 035 4549647
info@it.bernstein.eu

**United Kingdom
BERNSTEIN Ltd**
Fon +44 1922 744999
Fax +44 1922 457555
info@uk.bernstein.eu

**Austria
BERNSTEIN GmbH**
Fon +43 2256 62070-0
Fax +43 2256 62618
info@at.bernstein.eu

**Switzerland
BERNSTEIN (Schweiz) AG**
Fon +41 44 775 71-71
Fax +41 44 775 71-72
info@ch.bernstein.eu

**Hungary
BERNSTEIN Kft.**
Fon +36 1 4342295
Fax +36 1 4342299
info@hu.bernstein.eu

**China
BERNSTEIN Safe Solutions
(Taicang) Co., Ltd.**
Fon +86 512 81608180
Fax +86 512 81608181
info@bernstein-safesolutions.cn